

SIGUARD Position Switches

Standard Position Switches

Metal enclosures, 40 and 56 mm wide

Further information

Operation, operating speed and travel or angle of actuators

Bars, cams, stops, etc. are used as actuating devices. The shape of the actuating device must provide the given angles for the leading and trailing edges.

Actuating speed in the direction of the plunger axis

The actuating speed in the case of position switches with slow-action contacts is not permitted to go lower than 15 mm/s for DC and 1 mm/s for AC. Position switches with snap-action contacts should be used when the speeds are lower.

Position switches with 2 or 4 contacts

Operation by a bar	Switch blocks	Nominal travel	Switch blocks	Nominal travel
○ operating point acc. to EN 50041	Terminal designation acc. to EN 50013	0-line reference line acc. to EN 50041		
V_{max} max. operating speed		S contact closed		
0-line reference line acc. to EN 50041		□ contact open		
H travel difference		* operating point on return		
→ direction of operation		** positive opening to IEC 60947-5-1		

Plungers

3SE2 100-B,
3SE2 120-B,
3SE2 404-B

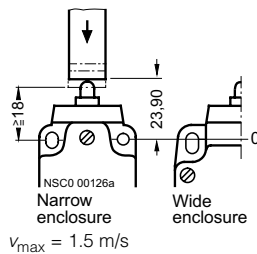

$V_{max} = 1.5 \text{ m/s}$

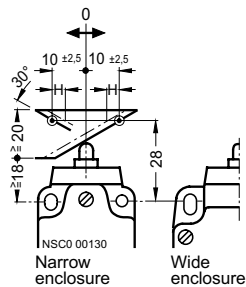

$V_{max} = 0.5 \text{ m/s}$

Minimum force required in direction of operation: 12 N

Slow-action contacts

1 NO + 1 NC

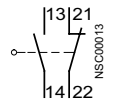

3SE3 000-0A,
3SE3 010-0A,
Ident. No. **11**

along plunger axis lateral actuation

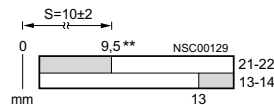
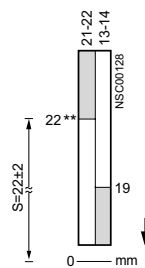

2 NC

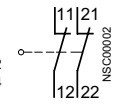

3SE3 000-6A,
Ident. No. **02**

along plunger axis

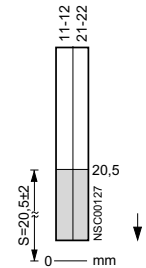

1 NO + 1 NC with make-before-break

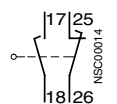

3SE3 000-3A,
3SE3 010-3A,
Ident. No. **11**

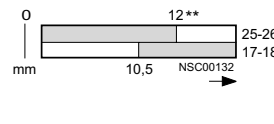
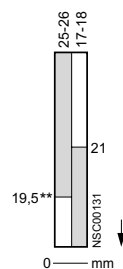

2 NO

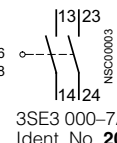

3SE3 000-7A,
Ident. No. **20**

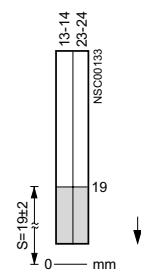

Snap-action contacts

1 NO + 1 NC

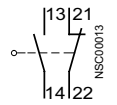

3SE3 000-1A,
3SE3 010-1A,
Ident. No. **11**

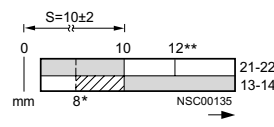
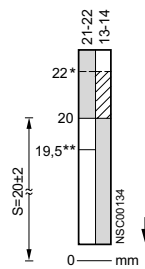

2 NO



3SE3 000-7A,
Ident. No. **20**



SIGUARD Position Switches

Standard Position Switches

Metal enclosures, 40 and 56 mm wide

Position switches with 2 or 4 contacts

Operation by a bar	Switch blocks	Nominal travel	Switch blocks	Nominal travel
○ operating point acc. to EN 50041	Terminal designation acc. to EN 50013	0-line reference line acc. to EN 50041		
v_{max} max. operating speed		S contact closed		
0-line reference line acc. to EN 50041		□ contact open		
H travel difference		* operating point on return		
→ direction of operation		** positive opening to IEC 60947-5-1		

Rounded plungers, Type B

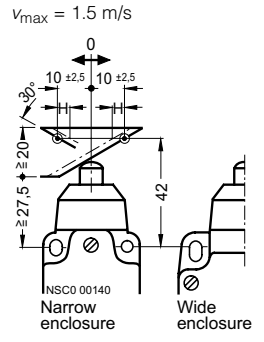
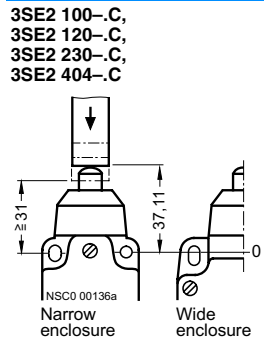

$v_{max} = 0.5 \text{ m/s}$
Minimum force required in direction of operation: 32 N

Slow-action contacts

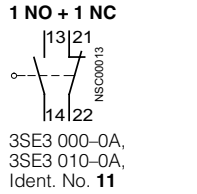

along plunger axis lateral actuation

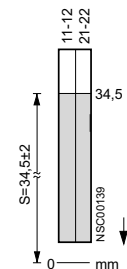
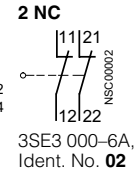
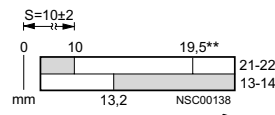
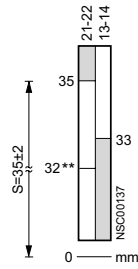

1 NO + 1 NC with make-before-break

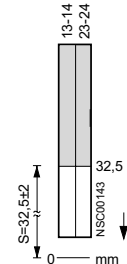
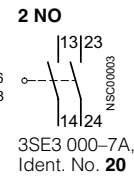
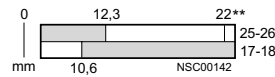
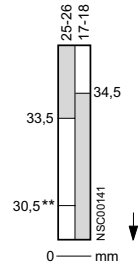
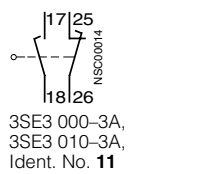

Snap-action contacts

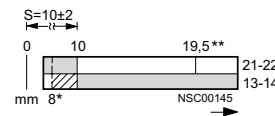
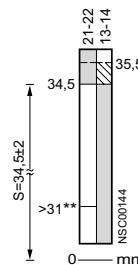
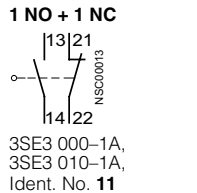

SIGUARD Position Switches

Standard Position Switches

Metal enclosures, 40 and 56 mm wide

Position switches with 2 or 4 contacts

Operation by a bar	Switch blocks	Nominal travel	Switch blocks	Nominal travel
○ operating point acc. to EN 50041	Terminal designation acc. to EN 50013	0-line reference line acc. to EN 50041		
V_{max} max. operating speed		S contact closed		
0-line reference line acc. to EN 50041		□ contact open		
H travel difference		* operating point on return		
→ direction of operation		** positive opening to IEC 60947-5-1		

Roller plungers, Type C

3SE2 100-D,
3SE2 120-D,
3SE2 230-D,
3SE2 404-D

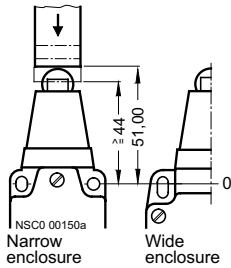

$V_{max} = 1.5$ m/s

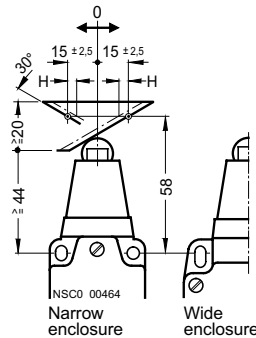

$V_{max} = 1$ m/s (3SE3 230-1D),
 $V_{max} = 0.5$ m/s (3SE3 1.0-1D),
Minimum force required in direction of operation: 32 N

Slow-action contacts

1 NO + 1 NC

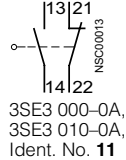

along plunger axis lateral actuation

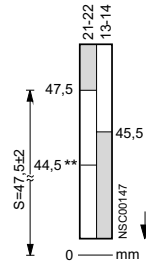

1 NO + 1 NC with make-before-break

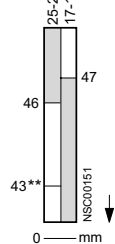
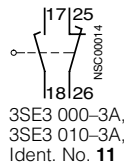

2 NC

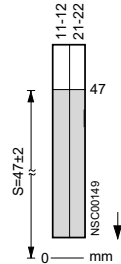
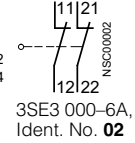

2 NO

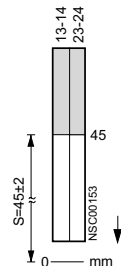
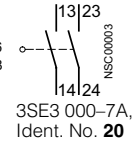

Snap-action contacts

1 NO + 1 NC

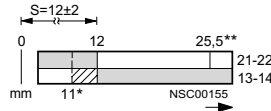
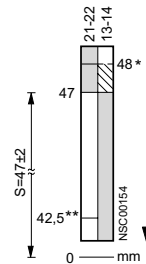
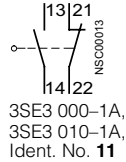

Fork levers

3SE2 100-1T,
3SE2 120-1T,
3SE2 404-1T

Lateral actuation

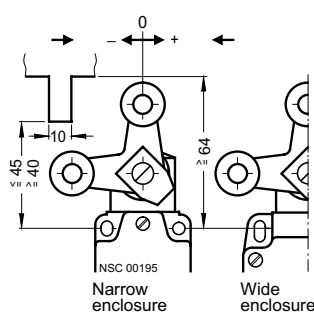

$V_{max} = 2$ m/s

Snap-action contacts

1 NO + 1 NC

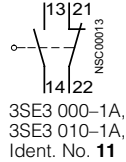

Deflection in direction of rotation

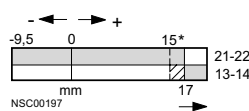
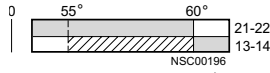

SIGUARD Position Switches

Standard Position Switches

Metal enclosures, 40 and 56 mm wide

Position switches with 2 or 4 contacts

Operation by a bar	Switch blocks	Nominal travel	Switch blocks	Nominal travel
<ul style="list-style-type: none"> ○ operating point acc. to EN 50041 a, g approach angle v_{max} max. operating speed 0-line reference line acc. to EN 50041 H travel difference → direction of operation 	Terminal designation acc. to EN 50013	0-line reference line acc. to EN 50041 S travel acc. to EN 50041 ■ contact closed □ contact open * operating point on return ** positive opening to IEC 60947-5-1		

Roller levers

3SE2 100-E, 3SE2 120-E, 3SE2 230-E, 3SE2 404-E

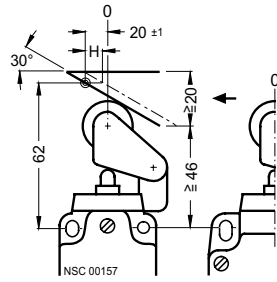

$v_{max} = 2.5 \text{ m/s}$

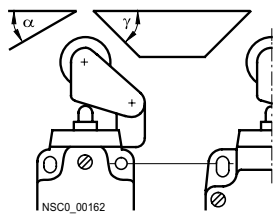

$v_{max} = 1 \text{ m/s}$, $\alpha_{max} = 30^\circ$, $\gamma_{max} = 45^\circ$

Minimum force required in direction of operation: 12 N

Slow-action contacts

1 NO + 1 NC

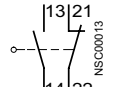

3SE3 000-0A, 3SE3 010-0A, Ident. No. 11

1 NO + 1 NC with make-before-break

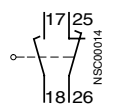

3SE3 000-3A, 3SE3 010-3A, Ident. No. 11

lateral actuation

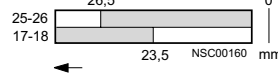
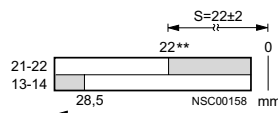

2 NC

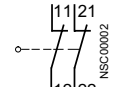

3SE3 000-6A, Ident. No. 02

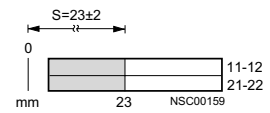

2 NO

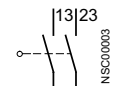

3SE3 000-7A, Ident. No. 20

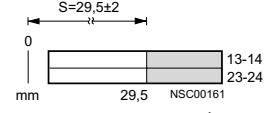

Angular roller levers

3SE2 100-F, 3SE2 120-F, 3SE2 230-F, 3SE2 404-F

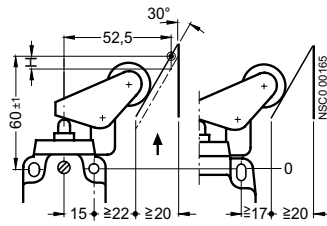

$v_{max} = 2.5 \text{ m/s}$

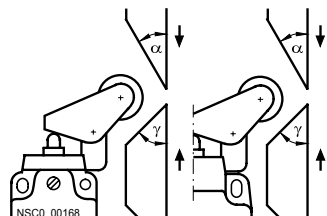

$v_{max} = 1 \text{ m/s}$, $\alpha_{max} = 30^\circ$, $\gamma_{max} = 45^\circ$

Minimum force required in direction of operation: 12 N

Slow-action contacts

1 NO + 1 NC

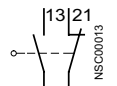

3SE3 000-0A, 3SE3 010-0A, Ident. No. 11

1 NO + 1 NC with make-before-break

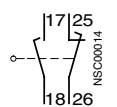

3SE3 000-3A, 3SE3 010-3A, Ident. No. 11

along plunger axis

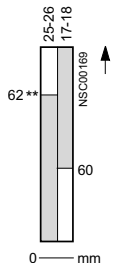
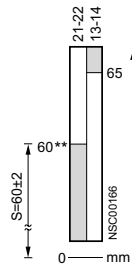

along plunger axis

2 NC

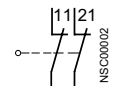

3SE3 000-6A, Ident. No. 02

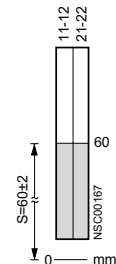

2 NO

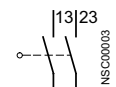

3SE3 000-7A, Ident. No. 20

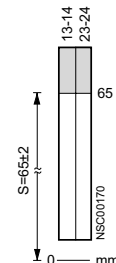

Snap-action contacts

1 NO + 1 NC

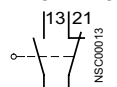

3SE3 000-1A, 3SE3 010-1A, Ident. No. 11

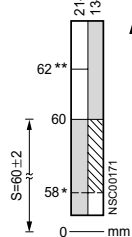

SIGUARD Position Switches

Standard Position Switches

Metal enclosures, 40 and 56 mm wide

Position switches with 2 or 4 contacts

Operation by a bar	Switch blocks	Nominal travel	Switch blocks	Nominal travel
○ operating point acc. to EN 50041	Terminal designation acc. to EN 50013	0-line reference line acc. to EN 50041		
a approach angle		S travel acc. to EN 50041		
b trailing angle		■ contact closed		
v_{max} max. operating speed		□ contact open		
0-line reference line acc. to EN 50041		* operating point on return		
S travel acc. to EN 50041		** positive opening acc. to IEC 60947-5-1		
H travel difference				
→ direction of operation				

Twist levers, Type A

repositionable and finely adjustable from 10° to 10°

3SE2 100--GW, 3SE2 120--GW, 3SE2 230--GW, 3SE2 404--GW

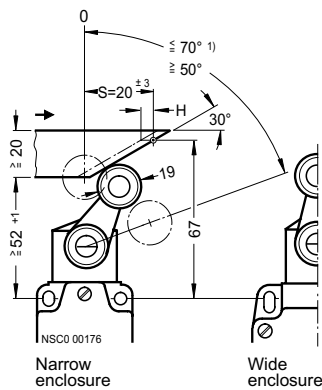

$v_{max} = 3 \text{ m/s}$

Minimum torque required in direction of operation: 25 Ncm

In special designs (Z = A31), contacts can only be operated from right or left. By twisting the plunger from the right and left.

Slow-action contacts

1 NO + 1 NC

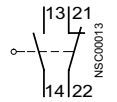

3SE3 000-0A, 3SE3 010-0A, Ident. No. **11**

lateral actuation

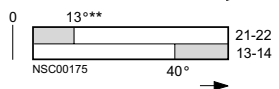
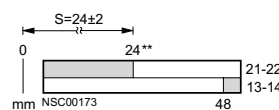

1 NO + 1 NC with make-before-break

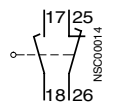

3SE3 000-3A, 3SE3 010-3A, Ident. No. **11**

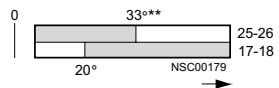
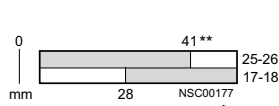

Snap-action contacts

1 NO + 1 NC

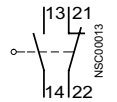

3SE3 000-1A, 3SE3 010-1A, Ident. No. **11**

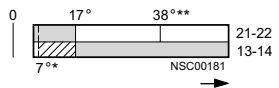
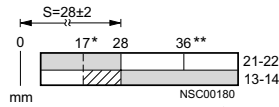

2 NC

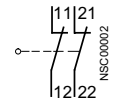

3SE3 000-6A, Ident. No. **02**

lateral actuation

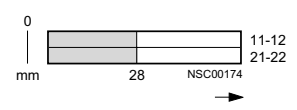

2 NO

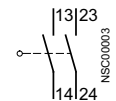

3SE3 000-7A, Ident. No. **20**

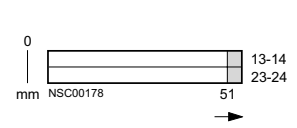

Twist levers, adjustable length

finely adjustable from 10° to 10°

3SE2 100--UW, 3SE2 120--UW, 3SE2 230--U, 3SE2 404--UW

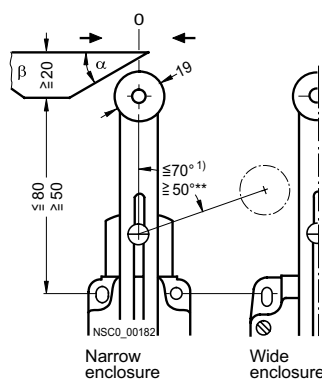

$v_{max} = 1 \text{ m/s}$, $\alpha_{max} = 30^\circ$, $\beta_{max} = 30^\circ$

Minimum torque required in direction of operation: 25 Ncm

Contact operation either from right or left or from right and left.

Slow-action contacts

1 NO + 1 NC

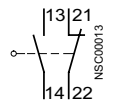

3SE3 000-0A, 3SE3 010-0A, Ident. No. **11**

Deflection in direction of rotation

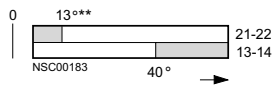

1 NO + 1 NC with make-before-break

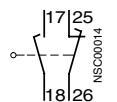

3SE3 000-3A, 3SE3 010-3A, Ident. No. **11**

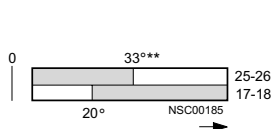

Snap-action contacts

1 NO + 1 NC

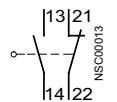

3SE3 000-1A, 3SE3 010-1A, Ident. No. **11**

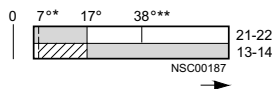

2 NC

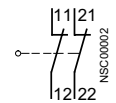

3SE3 000-6A, Ident. No. **02**

Deflection in direction of rotation

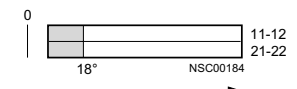

2 NO

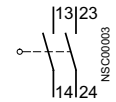

3SE3 000-7A, Ident. No. **20**

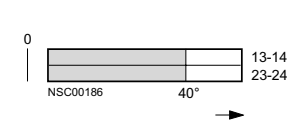

1) Max. operating angle 70°.

SIGUARD Position Switches

Standard Position Switches

Metal enclosures, 40 and 56 mm wide

Position switches with 2 or 4 contacts

Operation by a bar	Switch blocks	Nominal travel	Switch blocks	Nominal travel
<ul style="list-style-type: none"> ○ operating point acc. to EN 50041 v_{max} max. operating speed 0-line reference line acc. to EN 50041 → direction of operation 	Terminal designation acc. to EN 50013	0-line reference line acc. to EN 50041 ■ contact closed □ contact open * operating point on return ** positive opening to IEC 60947-5-1		

Rod actuators

finely adjustable from 10° to 10°

- 3SE2 100-WW, 3SE2 120-WW, 3SE2 230-W, 3SE2 404-WW
- 3SE2 100-VW, 3SE2 120-VW, 3SE2 230-V, 3SE2 404-VW

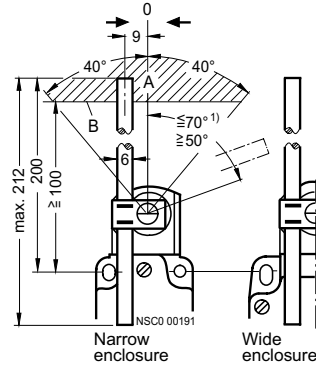

A = Operating range
 B = Lower edge of actuator
 $v_{max} = 3 \text{ m/s}$
 Minimum torque required in direction of operation: 25 Ncm
 In special designs (Z = A31), contacts can only be operated from right or left. By twisting the plunger from the right and left.

Slow-action contacts

1 NO + 1 NC

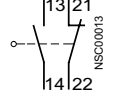

3SE3 000-0A, 3SE3 010-0A, Ident. No. 11

1 NO + 1 NC with make-before-break

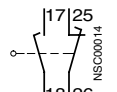

3SE3 000-3A, 3SE3 010-3A, Ident. No. 11

in direction of rotation

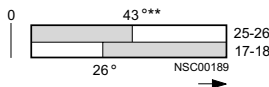
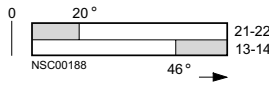

in direction of rotation

2 NC

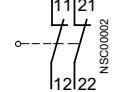

3SE3 000-6A, Ident. No. 02

2 NO

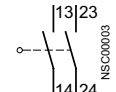

3SE3 000-7A, Ident. No. 20

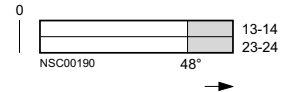
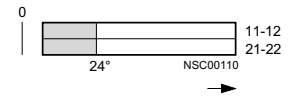

Snap-action contacts

1 NO + 1 NC

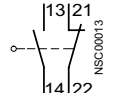

3SE3 000-1A, 3SE3 010-1A, Ident. No. 11

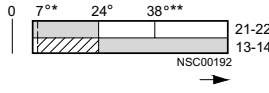

Spring rods

- 3SE2 100-1R, 3SE2 120-1R, 3SE2 230-1R

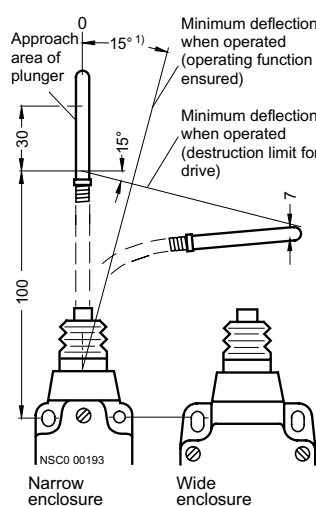

$v_{max} = 1 \text{ m/s}$, approachable from all sides
 Minimum force required in direction of operation: 12 N
 with lateral deflection at the tip: 2.5 N

Snap-action contacts

1 NO + 1 NC

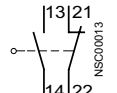

3SE3 000-1A, 3SE3 010-1A, Ident. No. 11

Deflection of spring rod

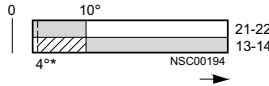

1) Max. operating angle 70°.

SIGUARD Position Switches

Standard Position Switches

Metal enclosures, 40 and 56 mm wide

Position switches with 3 contacts

Operation by a bar	Switch blocks	Nominal travel	Minimum force required in direction of operation
<ul style="list-style-type: none"> ○ operating point acc. to EN 50041 v_{max} max. operating speed 0-line reference line acc. to EN 50041 H travel difference → direction of operation 	Terminal designations acc. to EN 50013	<ul style="list-style-type: none"> 0-line reference line acc. to EN 50041 S travel acc. to EN 50041 ■ contact closed □ contact open * operating point on return ** positive opening to IEC 60947-5-1 	

Plungers	Slow-action contacts	along plunger axis	lateral actuation	Minimum force required in direction of operation
<p>3SE2 303-B</p> <p>NSC 00203a</p> <p>$v_{max} = 1.5 \text{ m/s}$</p>	<p>1 NO + 2 NC</p> <p>NSC00105</p> <p>Ident. No. 12</p>	<p>NSC00204</p>	<p>NSC00205</p>	16 N
<p>NSC 00206</p> <p>$v_{max} = 0.5 \text{ m/s}$</p>	<p>2 NO + 1 NC</p> <p>NSC00106</p> <p>Ident. No. 21</p>	<p>NSC00207</p>	<p>NSC00208</p>	18 N
	<p>1 NO + 2 NC with make-before-break</p> <p>NSC00107</p> <p>Ident. No. 12</p>	<p>NSC00209</p>	<p>NSC00210</p>	16 N
	<p>2 NO + 1 NC with make-before-break</p> <p>NSC00108</p> <p>Ident. No. 21</p>	<p>NSC00211</p>	<p>NSC00212</p>	18 N

SIGUARD Position Switches

Standard Position Switches

Metal enclosures, 40 and 56 mm wide

Position switches with 3 contacts

Operation by a bar	Switch blocks	Nominal travel	Minimum force required in direction of operation
<ul style="list-style-type: none"> ○ operating point acc. to EN 50041 v_{max} max. operating speed 0-line reference line acc. to EN 50041 H travel difference → direction of operation 	Terminal designation acc. to EN 50013	<ul style="list-style-type: none"> 0-line reference line acc. to EN 50041 S travel acc. to EN 50041 ■ contact closed □ contact open * operating point on return ** positive opening to IEC 60947-5-1 	

Rounded plungers	Slow-action contacts	along plunger axis	lateral actuation	
------------------	----------------------	--------------------	-------------------	--

3SE2 303-C	1 NO + 2 NC			35 N
-------------------	--------------------	--	--	------

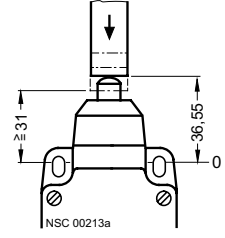

$v_{max} = 1.5$ m/s

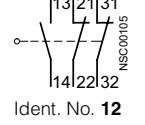

Ident. No. **12**

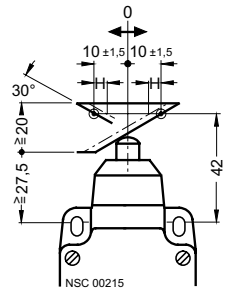
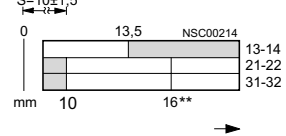
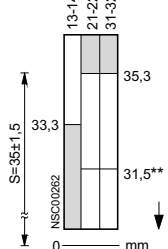

$v_{max} = 0.5$ m/s

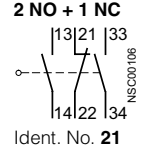

Ident. No. **21**

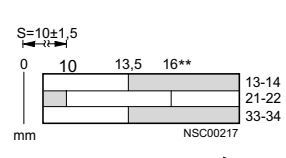
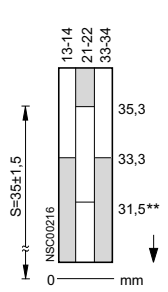

	1 NO + 2 NC with make-before-break			35 N
--	---	--	--	------

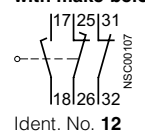

Ident. No. **12**

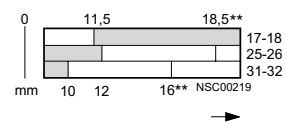
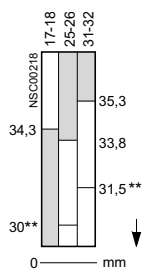

	2 NO + 1 NC with make-before-break			37 N
--	---	--	--	------

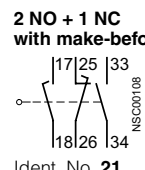

Ident. No. **21**

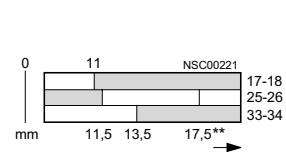
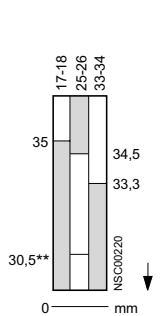

SIGUARD Position Switches

Standard Position Switches

Metal enclosures, 40 and 56 mm wide

Position switches with 3 contacts

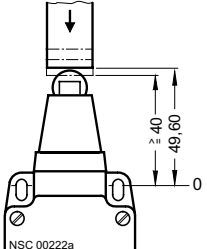
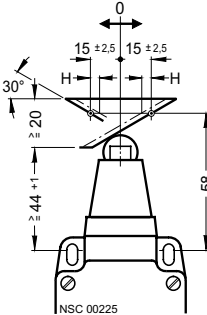
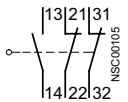
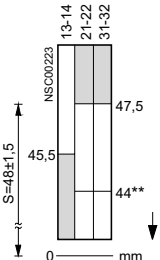
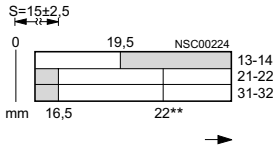
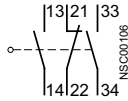
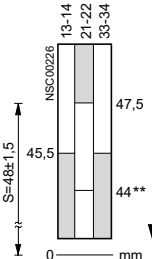
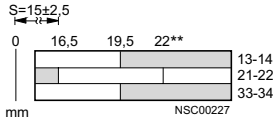
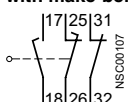
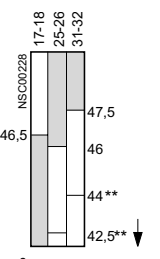
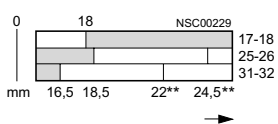
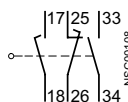
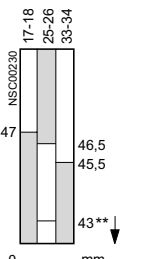
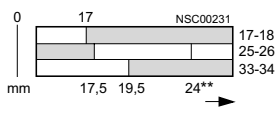
Operation by a bar	Switch blocks	Nominal travel	Minimum force required in direction of operation
<p>○ operating point acc. to EN 50041</p> <p>v_{max} max. operating speed</p> <p>0-line reference line acc. to EN 50041</p> <p>H travel difference</p> <p>→ direction of operation</p>	<p>Terminal designation acc. to EN 50013</p>	<p>0-line reference line acc. to EN 50041</p> <p>S travel acc. to EN 50041</p> <p>■ contact closed</p> <p>□ contact open</p> <p>* operating point on return</p> <p>** positive opening to IEC 60947-5-1</p>	
Roller plungers			
<p>3SE2 303-D</p>  <p>NSC 00222a</p> <p>$v_{max} = 1.5 \text{ m/s}$</p>  <p>NSC 00225</p> <p>$v_{max} = 1 \text{ m/s}$</p>	<p>Slow-action contacts</p> <p>1 NO + 2 NC</p>  <p>NSC00105</p> <p>Ident. No. 12</p>  <p>NSC00223</p> <p>mm</p>  <p>NSC00224</p> <p>mm</p> <p>35 N</p>		
	<p>2 NO + 1 NC</p>  <p>NSC00106</p> <p>Ident. No. 21</p>  <p>NSC00226</p> <p>mm</p>  <p>NSC00227</p> <p>mm</p> <p>37 N</p>		
	<p>1 NO + 2 NC with make-before-break</p>  <p>NSC00107</p> <p>Ident. No. 12</p>  <p>NSC00228</p> <p>mm</p>  <p>NSC00229</p> <p>mm</p> <p>35 N</p>		
	<p>2 NO + 1 NC with make-before-break</p>  <p>NSC00108</p> <p>Ident. No. 21</p>  <p>NSC00230</p> <p>mm</p>  <p>NSC00231</p> <p>mm</p> <p>37 N</p>		

SIGUARD Position Switches

Standard Position Switches

Metal enclosures, 40 and 56 mm wide

Position switches with 3 contacts

Operation by a bar	Switch blocks	Nominal travel	Minimum force required in direction of operation
<ul style="list-style-type: none"> ○ operating point acc. to EN 50041 a approach angle b trailing angle g approach angle v_{max} max. operating speed 0-line reference line acc. to EN 50041 H travel difference → direction of operation 	Terminal designation acc. to EN 50013	<ul style="list-style-type: none"> 0-line reference line acc. to EN 50041 S travel acc. to EN 50041 ■ contact closed □ contact open ** positive opening to IEC 60947-5-1 	

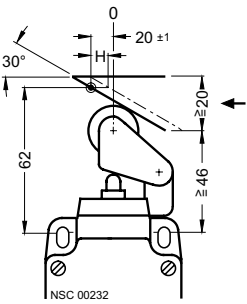
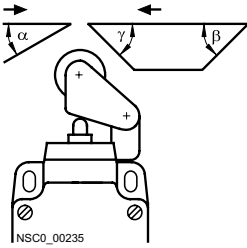
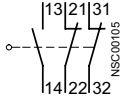
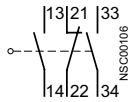
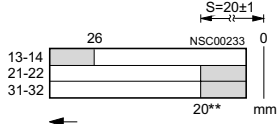
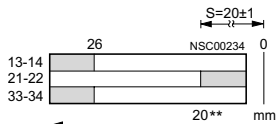
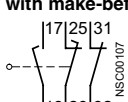
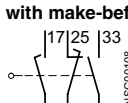
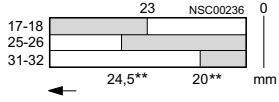
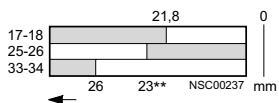
Roller levers	Slow-action contacts	lateral actuation	Minimum force required in direction of operation
3SE2 303--E   For lateral actuation: $v_{max} = 1 \text{ m/s}$ at $\alpha_{max} = 30^\circ$ $v_{max} = 2.5 \text{ m/s}$ at $\gamma_{max} = 45^\circ$ $\beta_{max} = 45^\circ$ For operation along plunger axis: $v_{max} = 1.5 \text{ m/s}$	1 NO + 2 NC  Ident. No. 12 2 NO + 1 NC  Ident. No. 21	 	15 N
	1 NO + 2 NC with make-before-break  Ident. No. 12 2 NO + 1 NC with make-before-break  Ident. No. 21	 	15 N

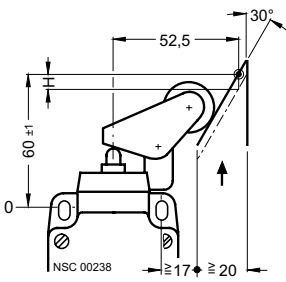
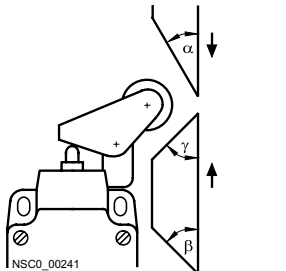
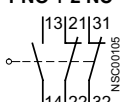
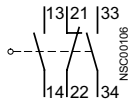
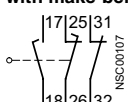
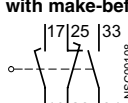
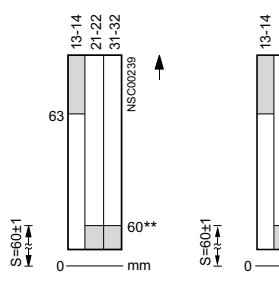
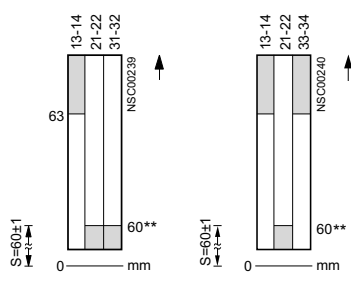
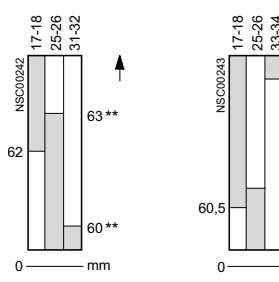
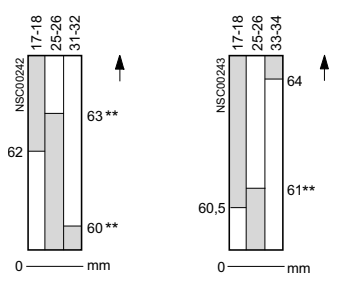
Angular roller levers	Slow-action contacts	along plunger axis	Minimum force required in direction of operation
3SE2 303--F   For operation along plunger axis: $v_{max} = 1 \text{ m/s}$ at $\alpha_{max} = 30^\circ$ $v_{max} = 2.5 \text{ m/s}$ at $\gamma_{max} = 45^\circ$ $v_{max} = 2.5 \text{ m/s}$ at $\beta_{max} = 45^\circ$	1 NO + 2 NC  Ident. No. 12 2 NO + 1 NC  Ident. No. 21 1 NO + 2 NC with make-before-break  Ident. No. 12 2 NO + 1 NC with make-before-break  Ident. No. 21	   	15 N
			17 N
			15 N
			17 N

SIGUARD Position Switches

Standard Position Switches

Metal enclosures, 40 and 56 mm wide

Position switches with 3 contacts

Operation by a bar	Switch blocks	Nominal travel	Minimum torque in direction of rotation
<ul style="list-style-type: none"> ○ operating point acc. to EN 50041 V_{max} max. operating speed 0-line reference line acc. to EN 50041 H travel difference → direction of operation 	Terminal designation acc. to EN 50013	<ul style="list-style-type: none"> 0-line reference line acc. to EN 50041 S travel acc. to EN 50041 ■ contact closed □ contact open ** positive opening to IEC 60947-5-1 	

Twist levers	Slow-action contacts	lateral actuation	25 Ncm
--------------	----------------------	-------------------	--------

finely adjustable from 10° to 10°

3SE2 303--GW-Z A31

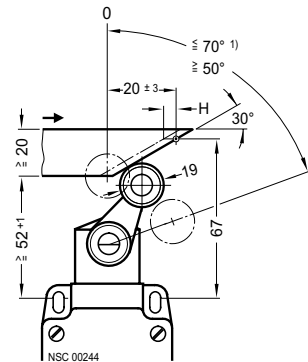

$V_{max} = 3 \text{ m/s}$

In special designs (Z = A31), contacts can only be operated from right or left. By twisting the plunger from the right and left.

1 NO + 2 NC

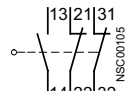

Ident. No. **12**

2 NO + 1 NC

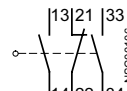

Ident. No. **21**

lateral actuation

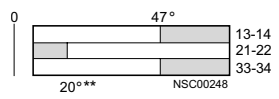
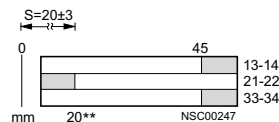
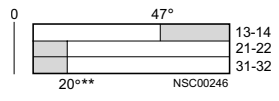
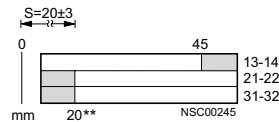

1 NO + 2 NC with make-before-break

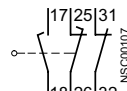

Ident. No. **12**

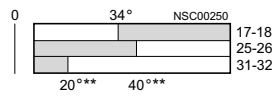
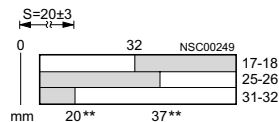

2 NO + 1 NC with make-before-break

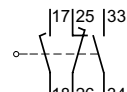

Ident. No. **21**

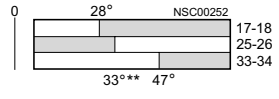
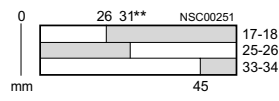

1) Max. operating angle 70°.
Max. deflection for adjustment purposes 90°.

SIGUARD Position Switches

Standard Position Switches

Metal enclosures, 40 and 56 mm wide

Position switches with 3 contacts

Operation by a bar	Switch blocks	Nominal travel	Minimum torque in direction of rotation
<ul style="list-style-type: none"> ○ operating point acc. to EN 50041 α approach angle β trailing angle v_{max} max. operating speed 0-line reference line acc. to EN 50041 → direction of operation 	Terminal designation acc. to EN 50013	<ul style="list-style-type: none"> 0-line reference line acc. to EN 50041 S travel acc. to EN 50041 contact closed contact open ** positive opening to IEC 60947-5-1 	Minimum torque in direction of rotation

Twist levers, adjustable length

finely adjustable from 10° to 10°

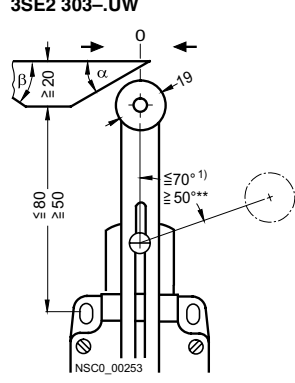

3SE2 303-UW

$v_{max} = 3 \text{ m/s}$,
 $\alpha_{max} = 30^\circ$,
 $\beta_{max} = 30^\circ$

In special designs (Z = A31), contacts can only be operated from right or left. By twisting the plunger from the right and left.

Slow-action contacts

1 NO + 2 NC

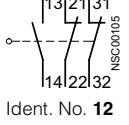

Ident. No. **12**

2 NO + 1 NC

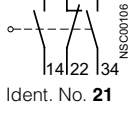

Ident. No. **21**

lateral actuation

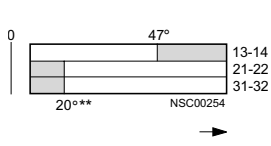

25 Ncm

1 NO + 2 NC with make-before-break

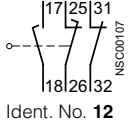

Ident. No. **12**

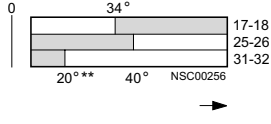

2 NO + 1 NC with make-before-break

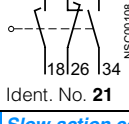

Ident. No. **21**

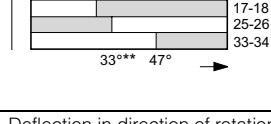

Rod actuators

finely adjustable from 10° to 10°

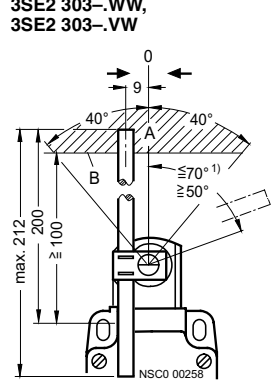

3SE2 303-WW, 3SE2 303-VW

A = Operating range
 B = Lower edge of actuator

$v_{max} = 3 \text{ m/s}$

In special designs (Z = A31), contacts can only be operated from right or left. By twisting the plunger from the right and left.

Slow-action contacts

1 NO + 2 NC

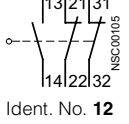

Ident. No. **12**

2 NO + 1 NC

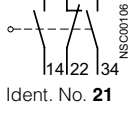

Ident. No. **21**

Deflection in direction of rotation

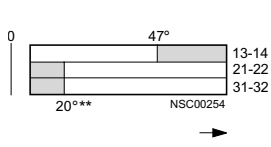

25 Ncm

1 NO + 2 NC with make-before-break

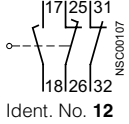

Ident. No. **12**

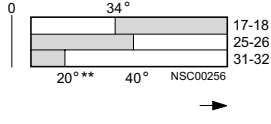

2 NO + 1 NC with make-before-break

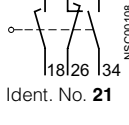

Ident. No. **21**

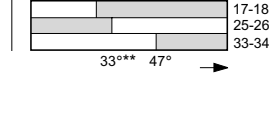

1) Max. operating angle 70°.
 Max. deflection for adjustment purposes 90°.